

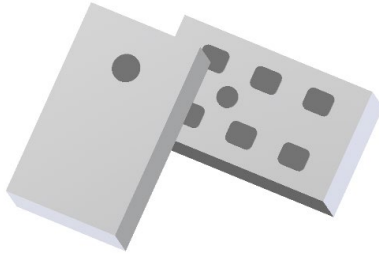

Ultra Small Low Profile 0603 Balun
50Ω to 150Ω Balanced



Description:

The BD2326L50150AHF2 is an ultra-small low profile balanced to unbalanced transformer designed for differential inputs and output locations on next generation wireless chipsets. The BD2326L50150AHF2 is ideal for high volume manufacturing and is higher performance than traditional ceramic baluns. The BD2326L50150AHF2 has an unbalanced port impedance of 50Ω and a 150Ω balanced port impedance. This transformation enables single ended signals to be applied to differential ports on modern integrated chipsets. The output ports have equal amplitude (-3dB) with 180 degree phase differential. The BD2326L50150AHF2 is available on tape and reel for pick and place high volume manufacturing.

Detailed Electrical Specifications:

Specifications subject to change without notice.

Features:	Parameter (25°C)	Min.	Typ.	Max	Unit	
<ul style="list-style-type: none"> • 2300 – 2600 MHz • 0.7mm Height Profile • 50 Ohm to 2 x 75 Ohm • Low Insertion Loss • Input to Output DC Isolation • Surface Mountable • Tape & Reel • Non-conductive Surface • RoHS Compliant • Halogen Free 	Frequency	2300		2600	MHz	
	Unbalanced Port Impedance		50		Ω	
	Balanced Port Impedance		150		Ω	
	Return Loss	12	17		dB	
	Insertion Loss*		0.8	1.1	dB	
	Amplitude Balance		0.5	1.0	dB	
	Phase Balance		4	10	Degrees	
	CMRR		29		dB	
	Power Handling @ 85°C				2	Watts
	Operating Temperature		-55		+140	°C

* Insertion Loss stated at room temperature (Insertion Loss is approximately 0.1 dB higher at +85 °C)

Outline Drawing:

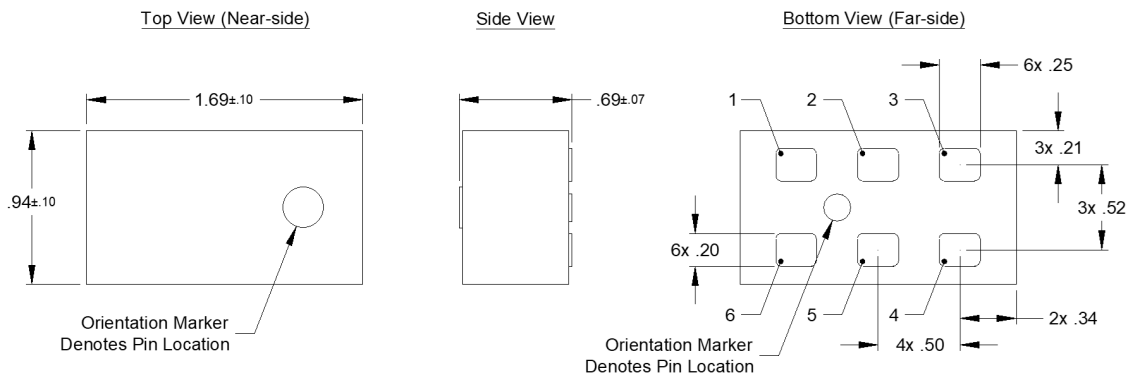

Pin	Designation
1	Unbalanced Port
2	DC Bias / Ground
3	Balanced Port
4	Balanced Port
5	Ground
6	NC

-Dimensions are in Millimeters
-Tolerances are Non-Cumulative

Insertion Loss and Power Derating Curves:

BD2326L50150AHF2 Typical Insertion Loss Derating Curve

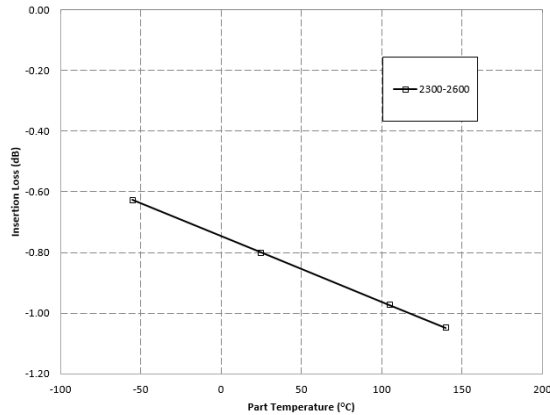

BD2326L50150AHF2 Power Derating Curve

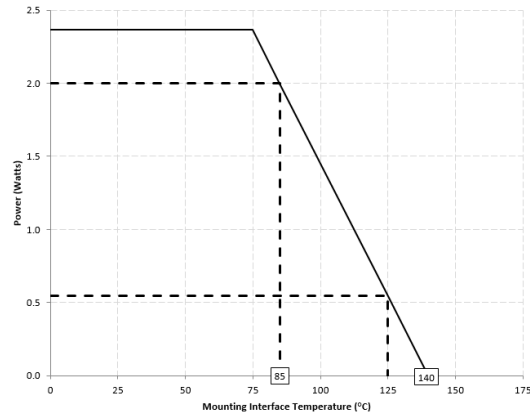

Insertion Loss Derating

The insertion loss, at a given frequency, of a group of Balun is measured at 25°C and then averaged. The measurements are performed under small signal conditions (i.e. using a Vector Network Analyzer). The process is repeated at -55°C and 140°C. A best-fit line for the measured data is computed and then plotted from -55°C to 140°C.

Power Derating

The power handling and corresponding power derating plots are a function of the thermal resistance, mounting surface temperature (base plate temperature), maximum continuous operating temperature of the Balun, and the thermal insertion loss. The thermal insertion loss is defined in the Power Handling section of the data sheet.

As the mounting interface temperature approaches the maximum continuous operating temperature, the power handling decreases to zero.

If mounting temperature is greater than 85°C, Xinger Balun will perform reliably as long as the input power is derated to the curve above.

Peak Power Handling

High-Pot testing of these components during the qualification procedure resulted in a minimum breakdown voltage of 1Kv (minimum recorded value). This voltage level corresponds to a breakdown resistance capable of handling at least 12dB peaks over average power levels, for very short durations. The breakdown location consistently occurred across the pads and the ground bar (see illustration below). The breakdown levels at these points will be affected by any contamination in the gap area around these pads. These areas must be kept clean for optimum performance. It is recommended that the user test for voltage breakdown under the maximum operating conditions and over worst case modulation induced power peaking. This evaluation should also include extreme environmental conditions (such as high humidity).

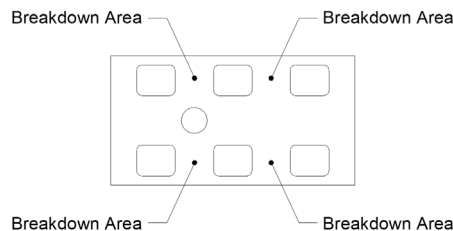

Typical Broadband Performance: 500 MHz to 6000 MHz

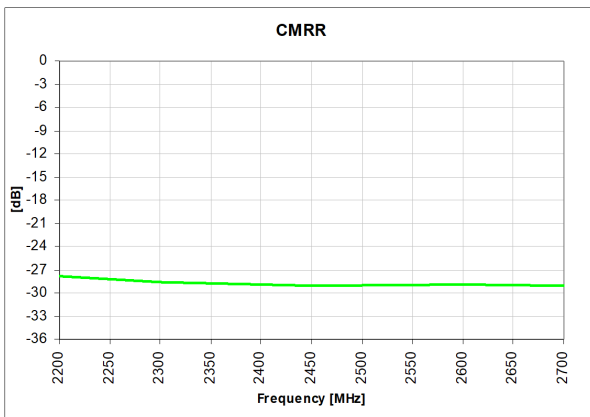
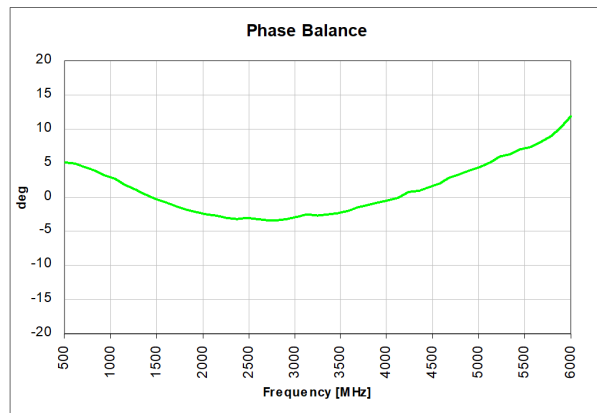
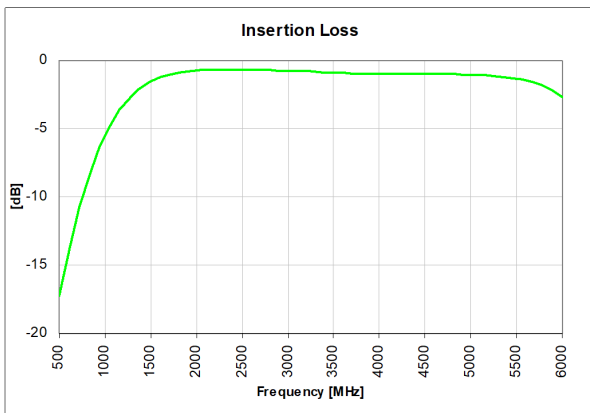
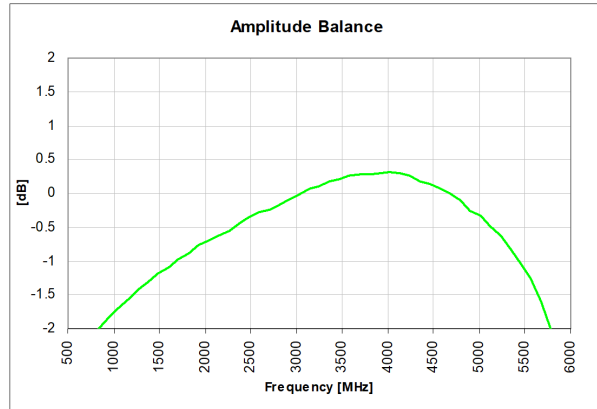
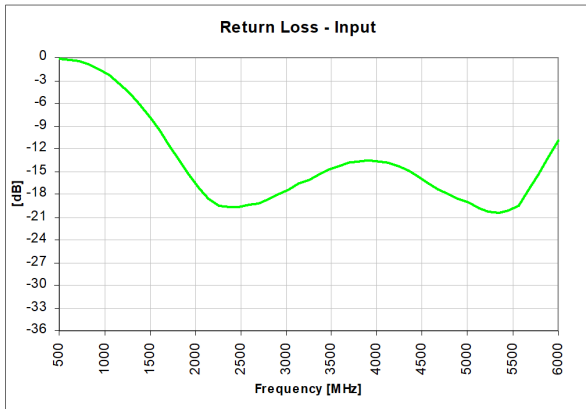

Typical Performance: 2200 MHz to 2700 MHz

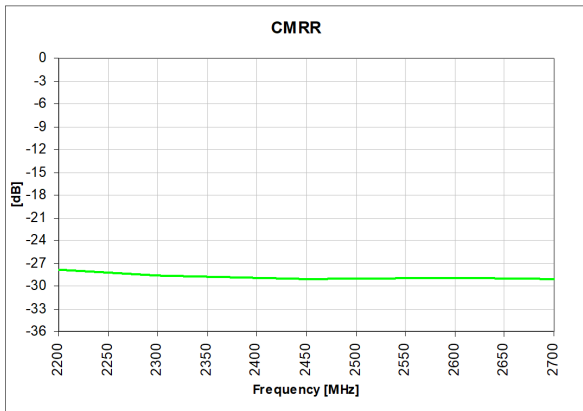
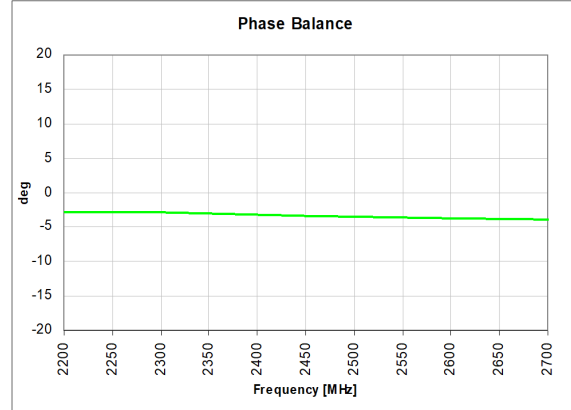
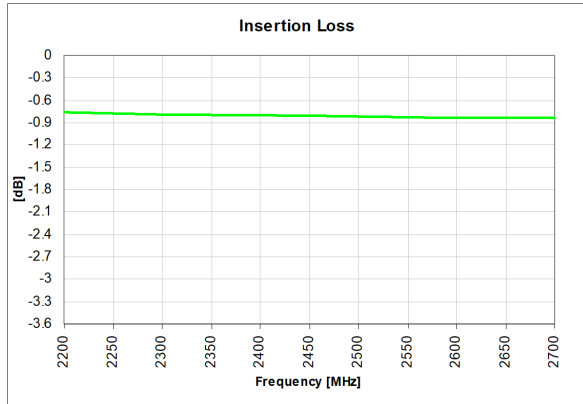
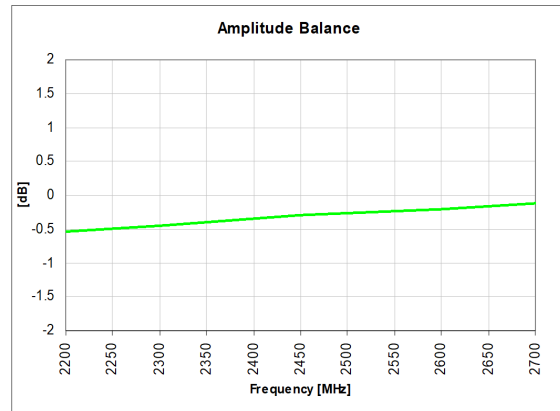
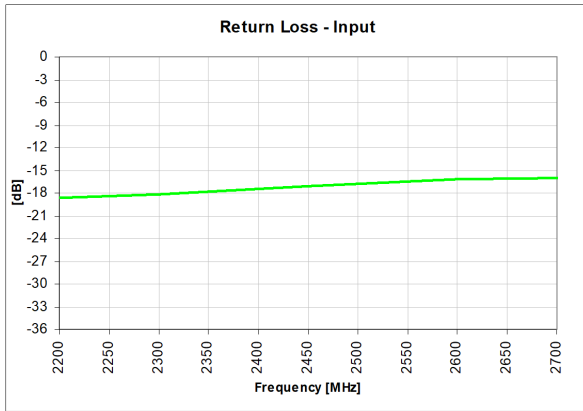

Packaging and Ordering Information:

Parts are available in reel and are packaged per EIA 481. Parts are oriented in tape and reel as shown below. Minimum order quantities are 4000 per reel.

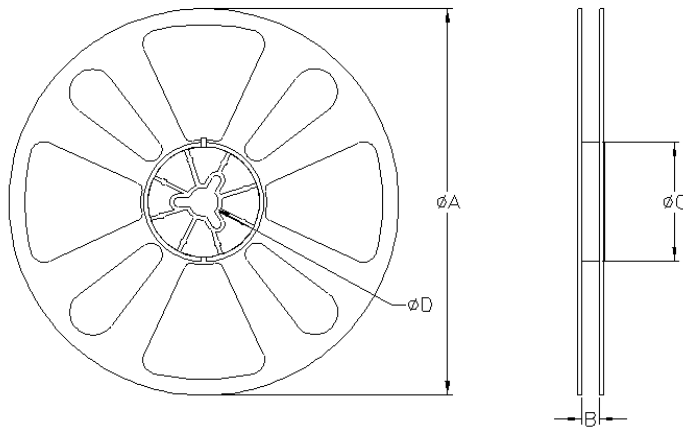
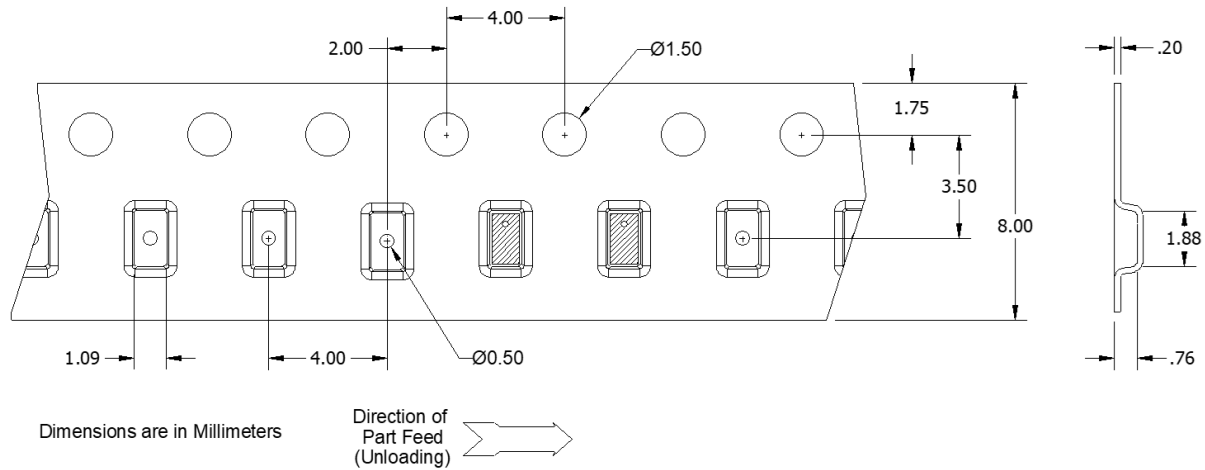

TABLE 1		
QUANTITY/REEL	REEL DIMENSIONS mm	
4000	ØA	177.80
	B	8.00
	ØC	50.80
	ØD	13.00

Contact us:
rf&s_support@ttm.com