

MS102-10*

DRAWN-SEAMLESS EMI/RFI SHIELD

*OPTIONAL SHIELD CONFIGURATIONS

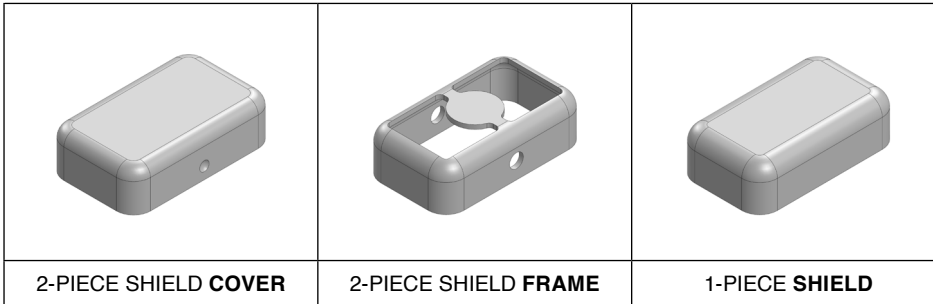

ITEM P/N	ITEM DESCRIPTION	MATERIAL
MS102-10C	2-PIECE EMI/RFI SHIELD COVER	TIN-PLATED STEEL
MS102-10F	2-PIECE EMI/RFI SHIELD FRAME	TIN-PLATED STEEL
MS102-10S	1-PIECE EMI/RFI SHIELD	TIN-PLATED STEEL
MS102-10C-NS	2-PIECE EMI/RFI SHIELD COVER	NICKEL-SILVER
MS102-10F-NS	2-PIECE EMI/RFI SHIELD FRAME	NICKEL-SILVER
MS102-10S-NS	1-PIECE EMI/RFI SHIELD	NICKEL-SILVER

TIN-PLATED STEEL: CRS ELECTROLYTIC TINPLATE
NICKEL-SILVER: UNS C77000 / UNS C73500



SHIELD CONFIGURATION:

MATERIAL:

© **MASACH TECH LTD.**
 22 HAGANAN, MODIIN 7169513 ISRAEL
 T: (+972) 8-9754681 / F: (+972) 8-9754682
info@masach.com / www.masach.com

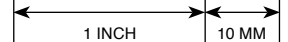

SHIELD TYPE:

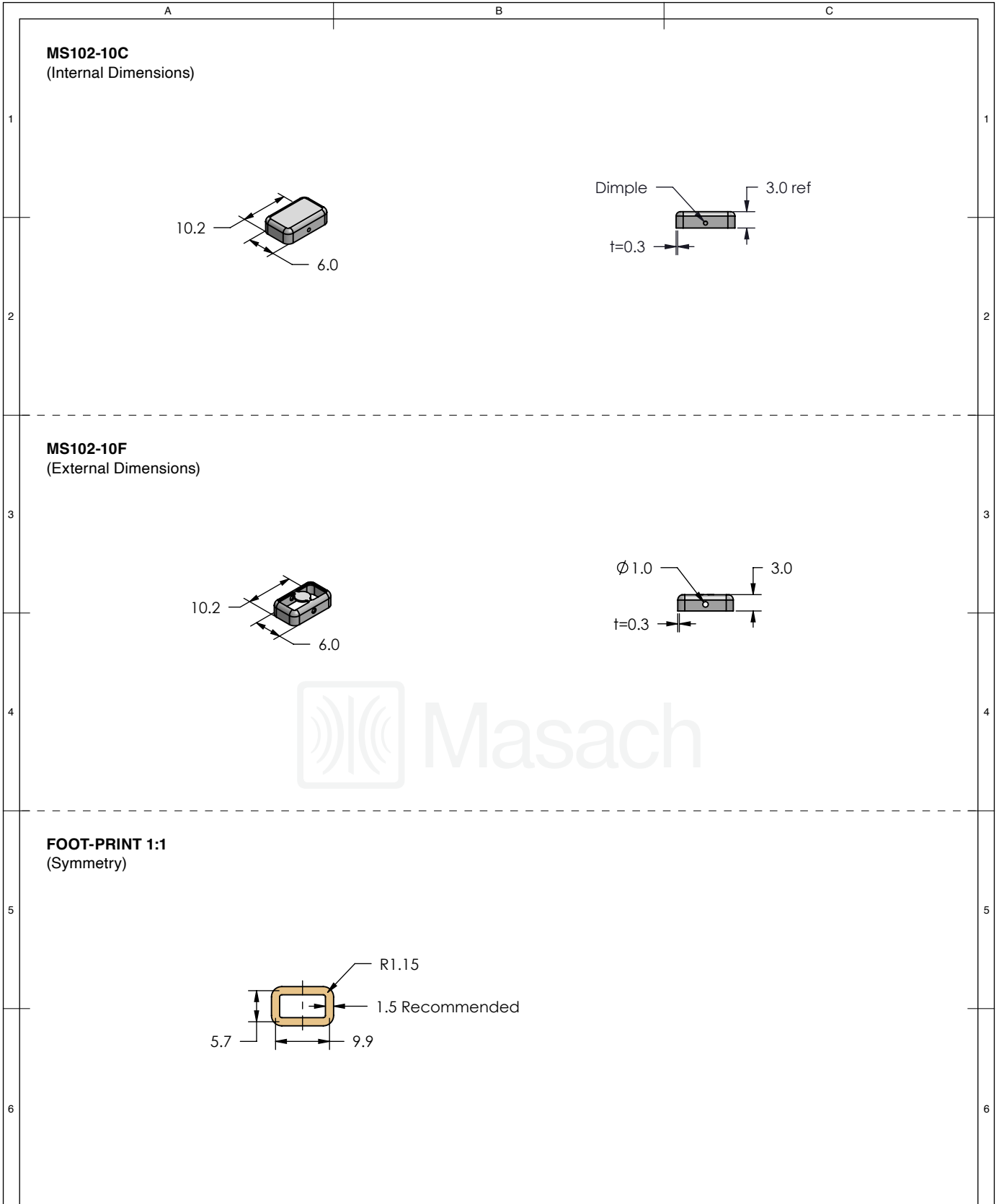

MMGS / PRINT 1:1 / A4

This product has been designed and manufactured by © Masach Tech Ltd. The use of this product in any type of electronic device or application is not under Masach Tech Ltd. liability.



	SHIELD CONFIGURATION:	MATERIAL:
	2-PIECE EM/RFI SHIELD	TIN-PLATED STEEL ⁽¹⁾
	<p>NOTE: (1) CRS ELECTROLYTIC TINPLATE (2) GENERAL TOLERANCE (+/-) 0.2MM</p>	
<p>© MASACH TECH LTD. 22 HAGANAN, MODIIN 7169513 ISRAEL T: (+972) 8-9754681 / F: (+972) 8-9754682 info@masach.com / www.masach.com</p>	<p>SHIELD TYPE:</p> <p style="text-align: center;">DRAWN-SEAMLESS EM/RFI SHIELD</p>	<div style="display: flex; align-items: center; justify-content: center;">   <div style="display: flex; align-items: center;"> <div style="border-bottom: 1px solid black; width: 100px; height: 10px; margin-right: 5px;"></div> <div style="margin-right: 5px;">1 INCH</div> </div> <div style="border-bottom: 1px solid black; width: 40px; height: 10px; margin-right: 5px;"></div> <div style="margin-right: 5px;">10 MM</div> </div> <p style="text-align: center; font-size: small;">MMGS / PRINT 1:1 / A4</p>

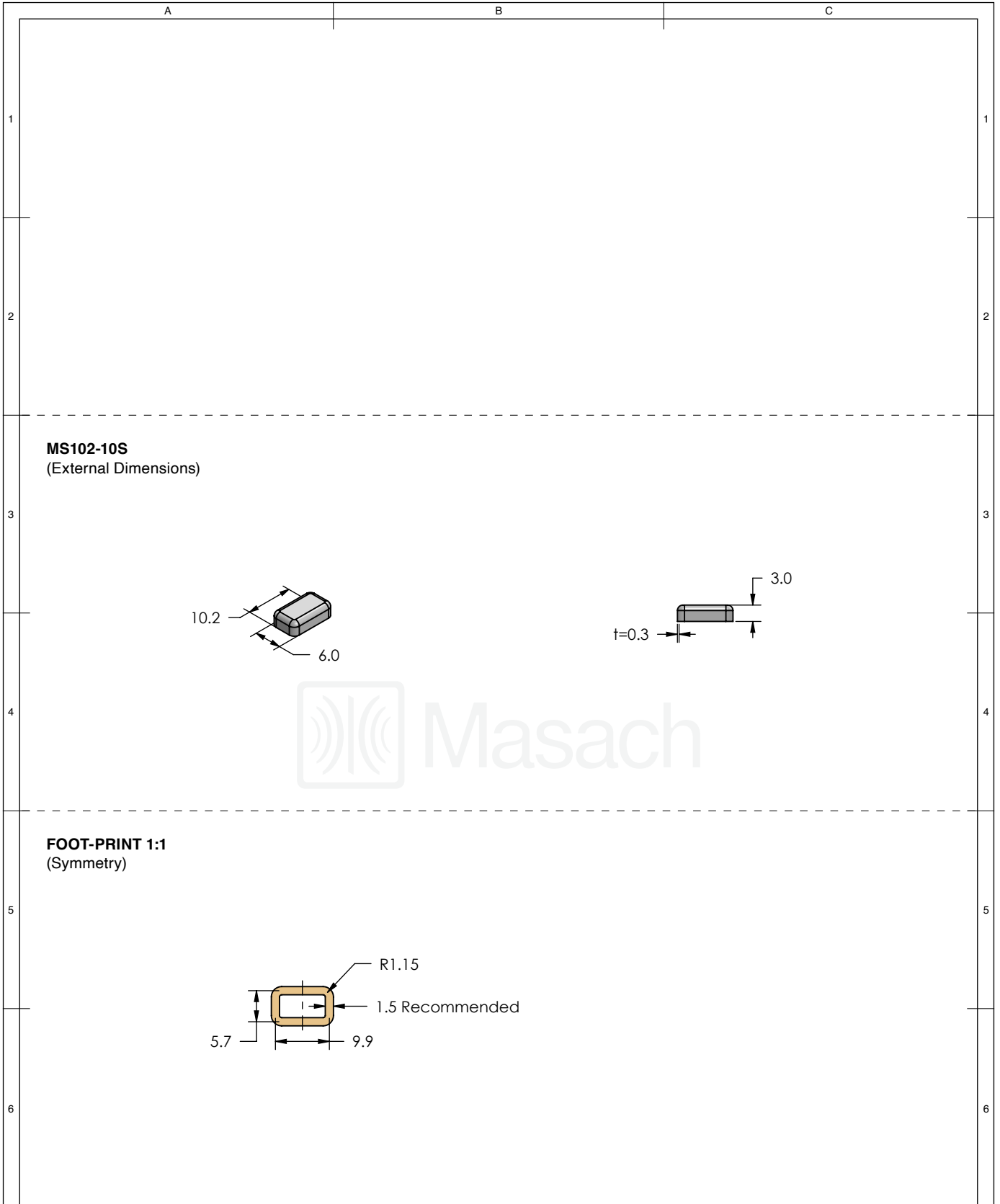

This product has been designed and manufactured by © Masach Tech Ltd. The use of this product in any type of electronic device or application is not under Masach Tech Ltd. liability.

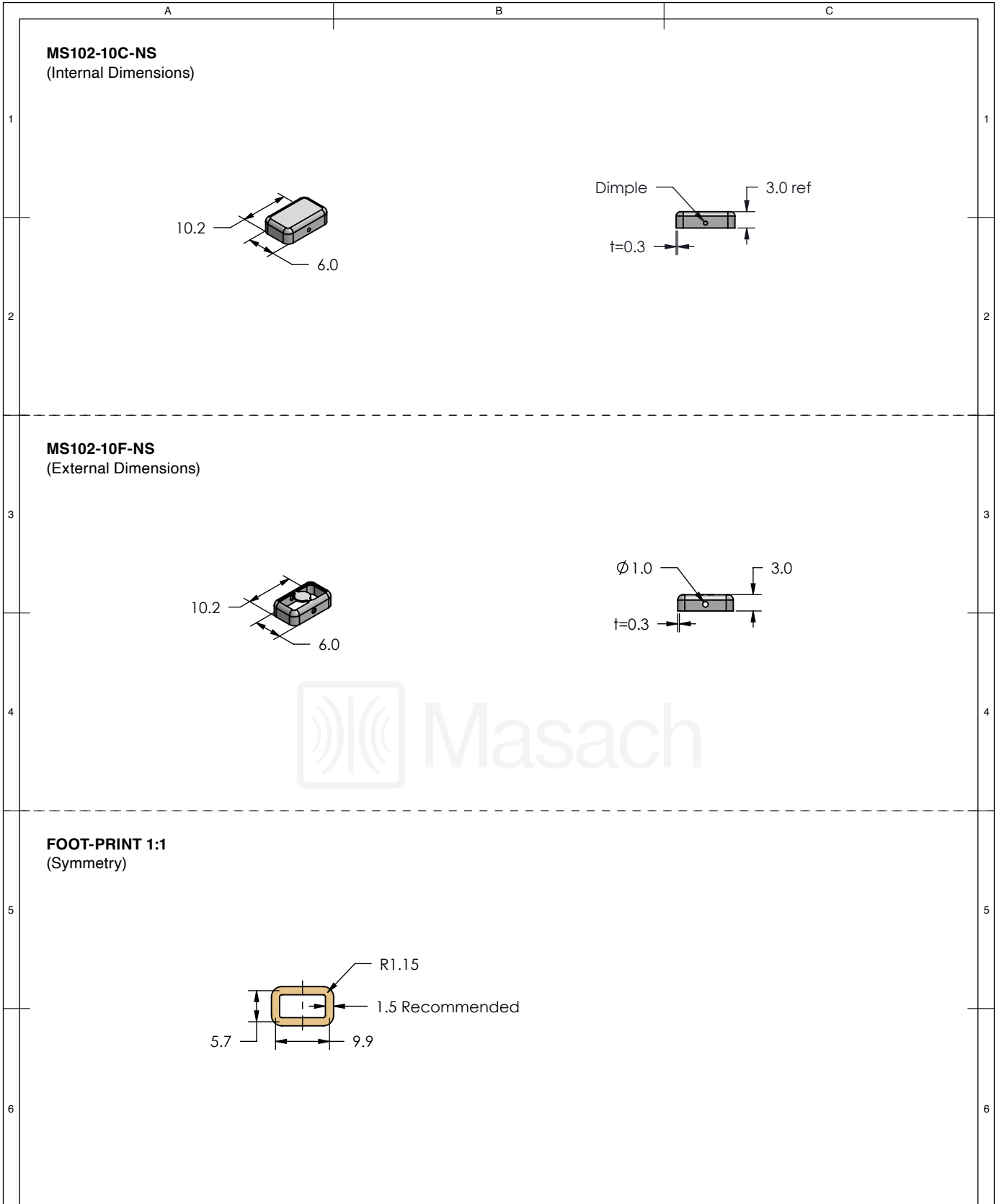

	SHIELD CONFIGURATION:	MATERIAL:
	1-PIECE EM/RFI SHIELD	TIN-PLATED STEEL ⁽¹⁾
NOTE: (1) CRS ELECTROLYTIC TINPLATE (2) GENERAL TOLERANCE (+/-) 0.2MM		
© MASACH TECH LTD. 22 HAGANAN, MODIIN 7169513 ISRAEL T: (+972) 8-9754681 / F: (+972) 8-9754682 info@masach.com / www.masach.com	SHIELD TYPE:	
	DRAWN-SEAMLESS EM/RFI SHIELD	<div style="display: flex; justify-content: space-around; align-items: center;"> <div style="text-align: center;"> </div> <div style="text-align: center;"> </div> </div> <p style="text-align: center;">MMGS / PRINT 1:1 / A4</p>

This product has been designed and manufactured by © Masach Tech Ltd. The use of this product in any type of electronic device or application is not under Masach Tech Ltd. liability.

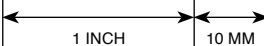

	SHIELD CONFIGURATION:		MATERIAL:	
	2-PIECE EM/RFI SHIELD		NICKEL-SILVER ⁽¹⁾	
	<p>NOTE: (1) UNS C77000 / UNS C73500 (2) GENERAL TOLERANCE (+/-) 0.2MM</p>			
<p>© MASACH TECH LTD. 22 HAGANAN, MODIIN 7169513 ISRAEL T: (+972) 8-9754681 / F: (+972) 8-9754682 info@masach.com / www.masach.com</p>	SHIELD TYPE:		 	
	DRAWN-SEAMLESS EM/RFI SHIELD			MMGS / PRINT 1:1 / A4

This product has been designed and manufactured by © Masach Tech Ltd. The use of this product in any type of electronic device or application is not under Masach Tech Ltd. liability.

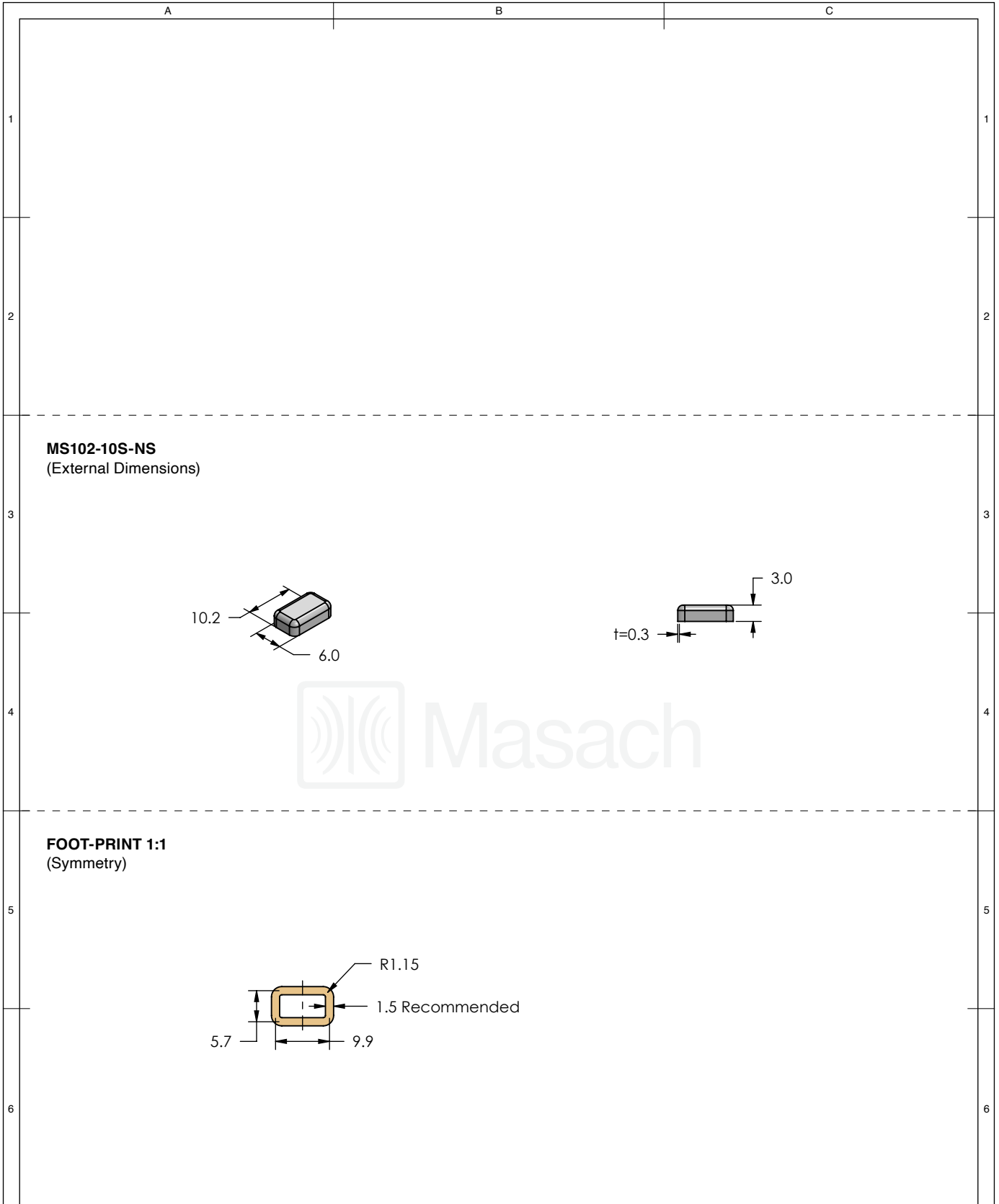

SHIELD CONFIGURATION:

1-PIECE EM/RFI SHIELD

MATERIAL:

NICKEL-SILVER ⁽¹⁾

NOTE: (1) UNS C77000 / UNS C73500 (2) GENERAL TOLERANCE (+/-) 0.2MM

© MASACH TECH LTD.
22 HAGANAN, MODIIN 7169513 ISRAEL
T: (+972) 8-9754681 / F: (+972) 8-9754682
info@masach.com / www.masach.com

SHIELD TYPE:

DRAWN-SEAMLESS EM/RFI SHIELD

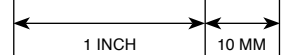

MMGS / PRINT 1:1 / A4

This product has been designed and manufactured by © Masach Tech Ltd. The use of this product in any type of electronic device or application is not under Masach Tech Ltd. liability.

A

B

C

MS102-10* SMT/SMD PACKING TRAY

* COMPATIBLE TO ALL SHIELD CONFIGURATIONS

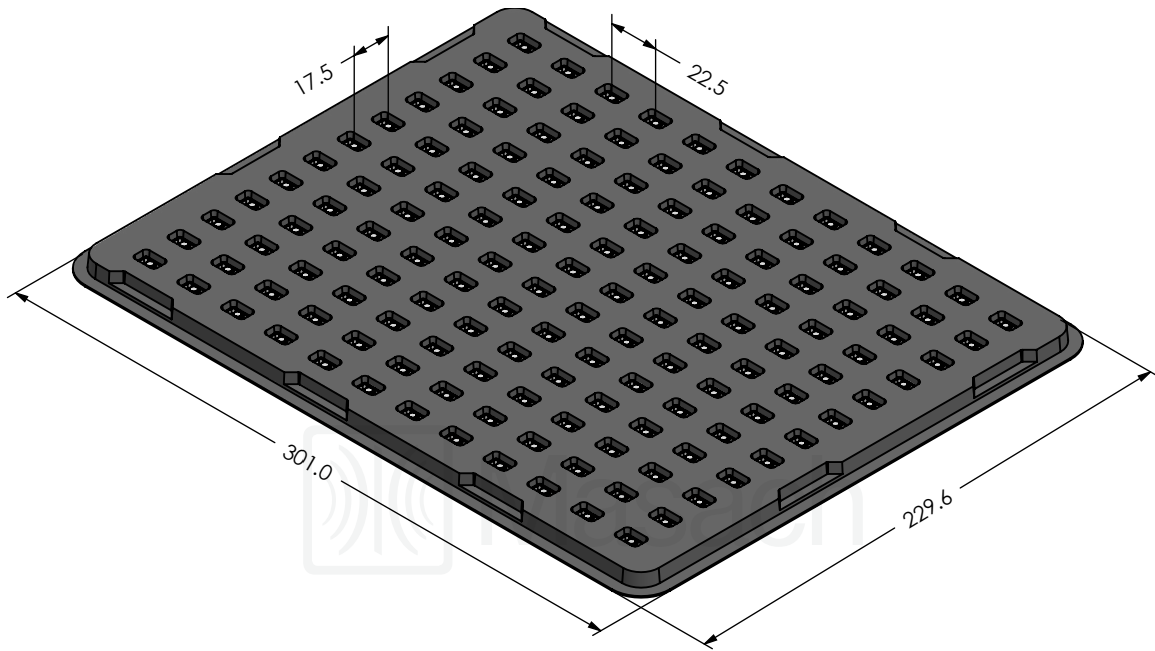

1

1

2

2

3

3

4

4

5

5

6

6



SHIELD CONFIGURATION:

MATERIAL:

© MASACH TECH LTD.
 22 HAGANAN, MODIIN 7169513 ISRAEL
 T: (+972) 8-9754681 / F: (+972) 8-9754682
info@masach.com / www.masach.com

SHIELD TYPE:



1 INCH 10 MM

MMGS / PRINT 1:1 / A4

This product has been designed and manufactured by © Masach Tech Ltd. The use of this product in any type of electronic device or application is not under Masach Tech Ltd. liability.

[BACK TO TOP](#)

Mouser Electronics

Authorized Distributor

Click to View Pricing, Inventory, Delivery & Lifecycle Information:

[Masach Tech:](#)

[MS102-10F](#) [MS102-10C](#) [MS102-10S](#) [MS102-10C-NS](#) [MS102-10F-NS](#) [MS102-10S-NS](#)