

### General Description

The IRFZ44NS/IRFZ44N uses advanced trench technology and design to provide excellent  $R_{DS(ON)}$  with low gate charge. It can be used in a wide variety of applications.

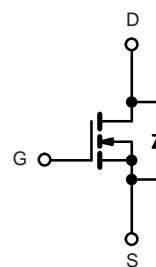

N-Channel MOSFET

### Product Summary

$V_{DS}$	60V
$I_D$ (at $V_{GS}=-10V$ )	50A
$R_{DS(ON)}$ (at $V_{GS}=10V$ )	< 12m $\Omega$
$R_{DS(ON)}$ (at $V_{GS}=4.5V$ )	< 16m $\Omega$

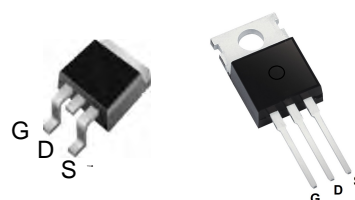

### Absolute Maximum Ratings(TA=25°C unless otherwise noted)

Parameter		Symbol	Value	Unit
Drain-Source Voltage		$V_{DS}$	60	V
Gate-Source Voltage		$V_{GS}$	$\pm 20$	V
Drain Current-Continuous <sup>Note3</sup>	TC=25°C	$I_D$	50	A
	TC=100°C		33	A
Drain Current-Pulsed <sup>Note1</sup>		$I_{DM}$	200	A
Avalanche Energy <sup>Note4</sup>		$E_{AS}$	64	mJ
Maximum Power Dissipation	TC=25°C	$P_D$	105	W
Storage Temperature Range		$T_{STG}$	-55 to +150	°C
Operating Junction Temperature Range		$T_J$	-55 to +150	°C

### Thermal Resistance

Parameter	Symbol	Min.	Typ.	Max	Unit
Thermal Resistance, Junction-to-Case	$R_{\theta JC}$	-	-	1.4	°C/W

### Electrical Characteristics(T<sub>J</sub>=25°C unless otherwise noted)

OFF CHARACTERISTICS						
Parameter	Symbol	Conditions	Min.	Typ.	Max.	Unit
Drain-Source Breakdown Voltage	BV <sub>DSS</sub>	V <sub>GS</sub> =0V, I <sub>DS</sub> =250uA	60	-	-	V
Zero Gate Voltage Drain Current	I <sub>DSS</sub>	V <sub>DS</sub> =60V, V <sub>GS</sub> =0V	-	-	1.0	uA
Gate-Body Leakage	I <sub>GSS</sub>	V <sub>GS</sub> =±20V, V <sub>DS</sub> =0V	-	-	±100	nA

ON CHARACTERISTICS						
Parameter	Symbol	Conditions	Min.	Typ.	Max.	Unit
Gate Threshold Voltage	V <sub>GS(TH)</sub>	V <sub>DS</sub> =V <sub>GS</sub> , I <sub>DS</sub> =250uA	1.0	1.6	2.5	V
Drain-Source On-State Resistance	R <sub>DS(ON)</sub>	V <sub>GS</sub> =10V, I <sub>DS</sub> =30A	-	12	17	mΩ
		V <sub>GS</sub> =4.5V, I <sub>DS</sub> =20A	-	16	21	mΩ

DYNAMIC CHARACTERISTICS						
Parameter	Symbol	Conditions	Min.	Typ.	Max.	Unit
Input Capacitance	C <sub>ISS</sub>	V <sub>DS</sub> =25V, V <sub>GS</sub> = 0V, f=1MHz	-	2928	-	pF
Output Capacitance	C <sub>OSS</sub>		-	141	-	
Reverse Transfer Capacitance	C <sub>rss</sub>		-	120	-	

SWITCHING CHARACTERISTICS						
Parameter	Symbol	Conditions	Min.	Typ.	Max.	Unit
Turn-On Delay Time	T <sub>d(on)</sub>	V <sub>GS</sub> =10V, V <sub>DS</sub> =30V, R <sub>GEN</sub> =1.8Ω I <sub>D</sub> =25A	-	7.5	-	ns
Rise Time	t <sub>r</sub>		-	6.0	-	
Turn-Off Delay Time	T <sub>d(off)</sub>		-	28.4	-	
Fall Time	t <sub>f</sub>		-	5.5	-	
Total Gate Charge at 10V	Q <sub>g</sub>	V <sub>DS</sub> =30V, I <sub>DS</sub> =25A, V <sub>GS</sub> =10V	-	50	-	nC
Gate to Source Gate Charge	Q <sub>gs</sub>		-	6	-	
Gate to Drain "Miller" Charge	Q <sub>gd</sub>		-	15	-	

DRAIN-SOURCE DIODE CHARACTERISTICS AND MAXIMUM RATINGS						
Parameter	Symbol	Conditions	Min.	Typ.	Max.	Unit
Drain-Source Diode Forward Voltage	V <sub>SD</sub>	V <sub>GS</sub> =0V, I <sub>DS</sub> =30A	-	-	1.2	V
Reverse Recovery Time	t <sub>rr</sub>	T <sub>J</sub> =25°C, I <sub>F</sub> =25A di/dt=100A/us	-	29	-	nS
Reverse Recovery Charge	Q <sub>rr</sub>		-	42	-	nC

#### Notes:

- 1: Repetitive rating, pulse width limited by maximum junction temperature.
- 2: Surface mounted on FR4 Board, t<sub>s</sub>≤10sec.
- 3: Pulse width ≤ 300μs, duty cycle ≤ 2%.
- 4: EAS condition: L=0.5mH, V<sub>DD</sub>=10V, V<sub>G</sub>=10V, V<sub>GATE</sub>=20V, Start T<sub>J</sub>=25°C.

**TYPICAL CHARACTERISTICS** (25 °C unless noted)

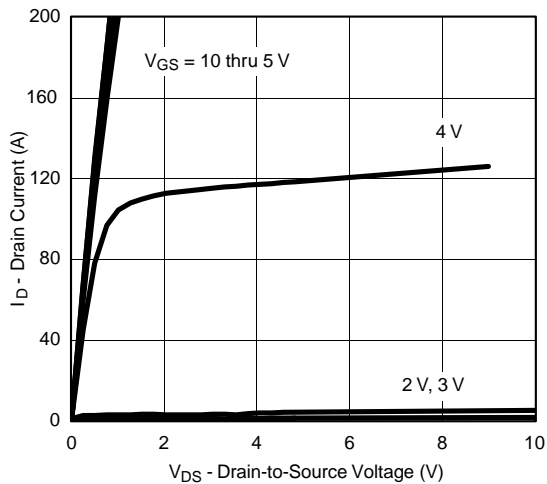

**Output Characteristics**

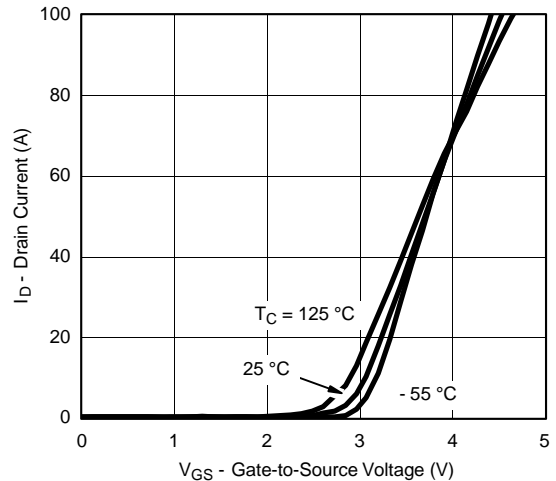

**Transfer Characteristics**

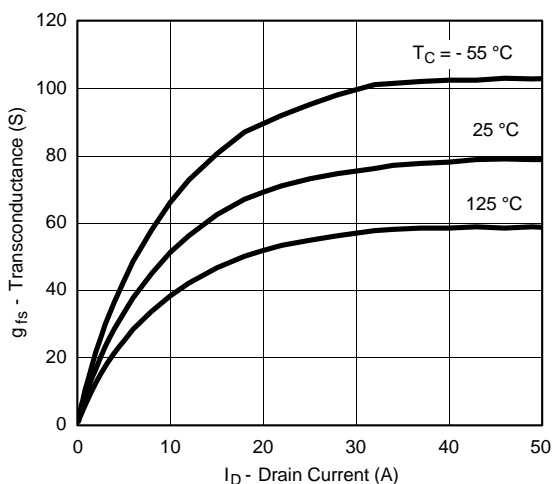

**Transconductance**

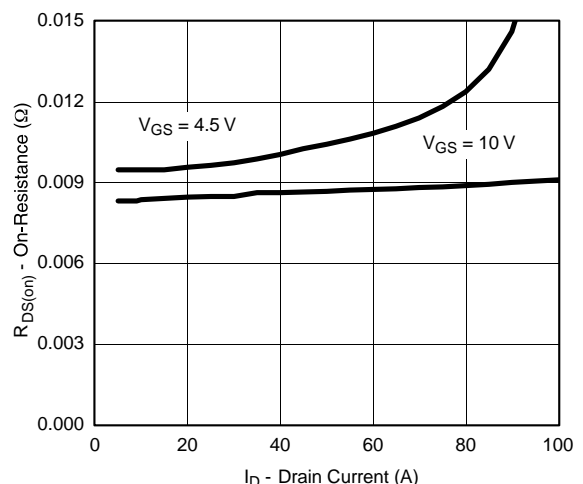

**On-Resistance vs. Drain Current**

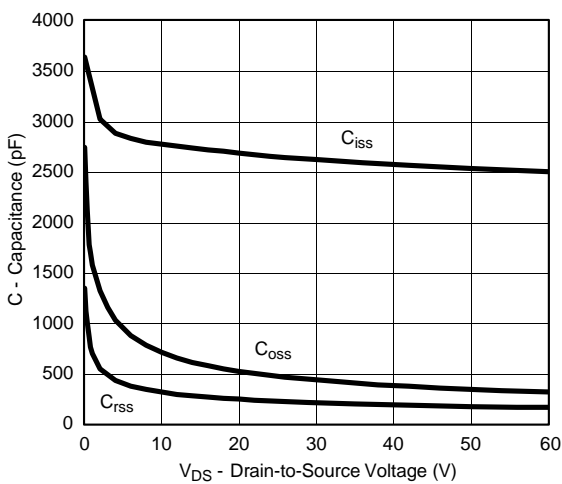

**Capacitance**

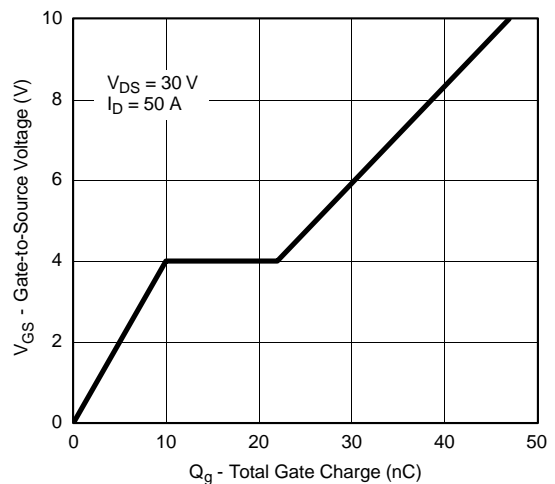

**Gate Charge**

**TYPICAL CHARACTERISTICS** (25 °C unless noted)

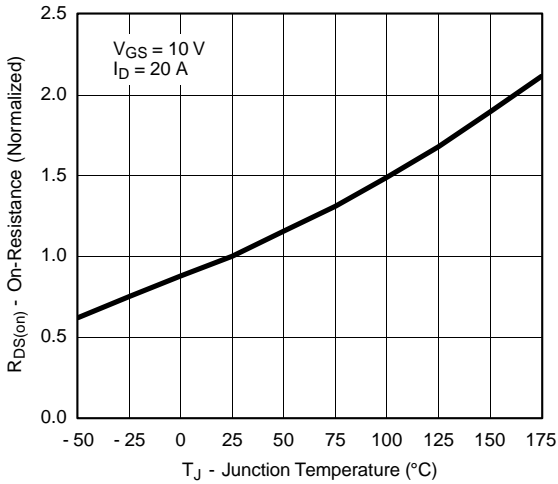

**On-Resistance vs. Junction Temperature**

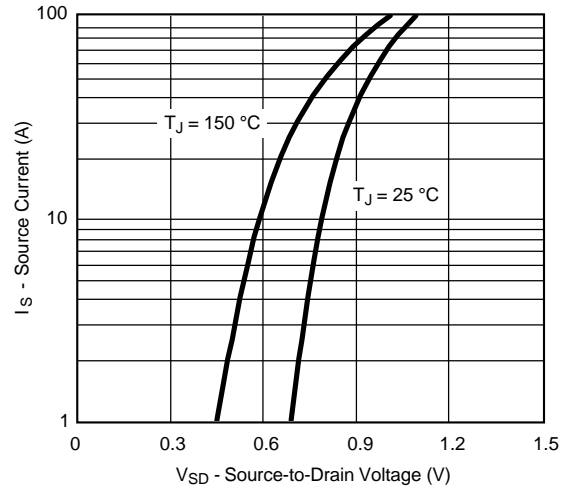

**Source-Drain Diode Forward Voltage**

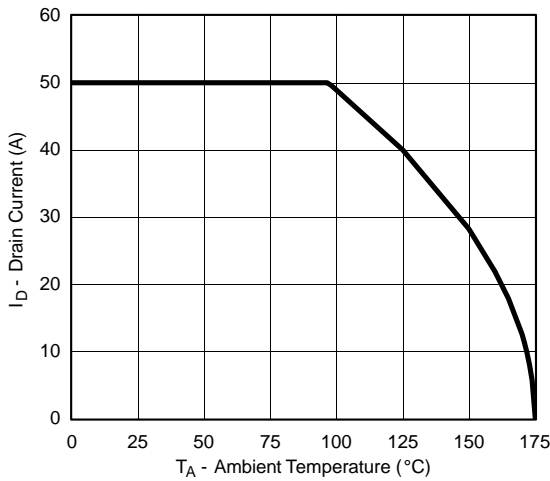

**Maximum Drain Current vs. Ambient Temperature**

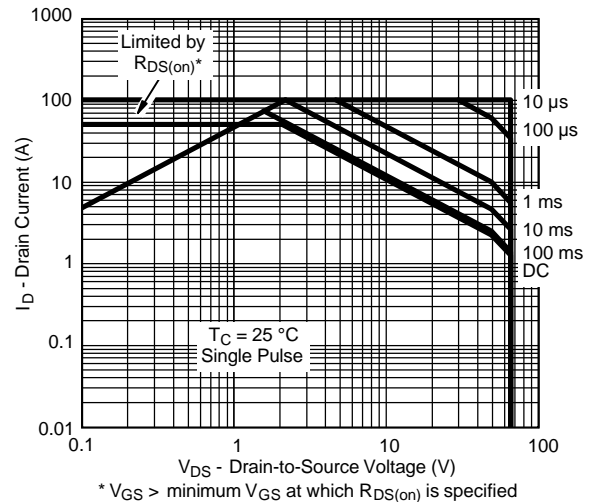

**Safe Operating Area**

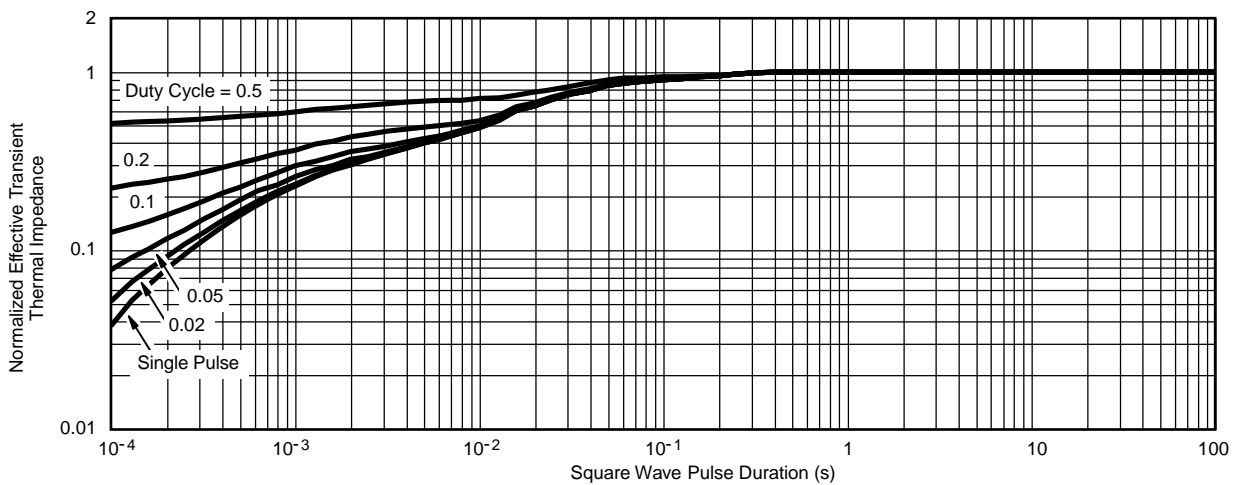

**Normalized Thermal Transient Impedance, Junction-to-Case**

Test Circuit

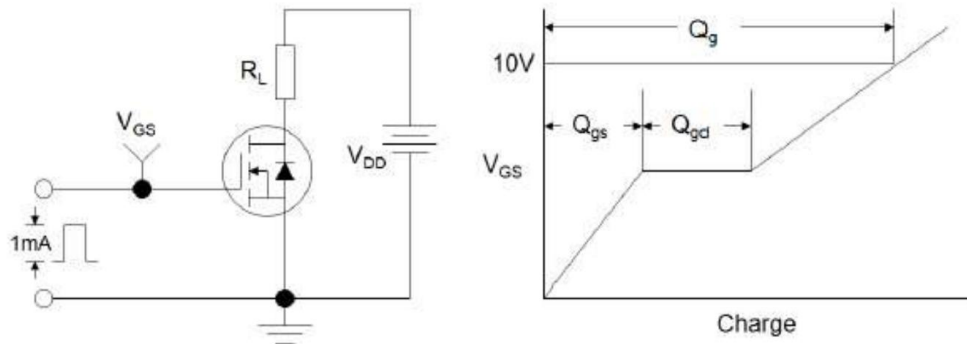

Figure 1: Gate Charge Test Circuit & Waveform

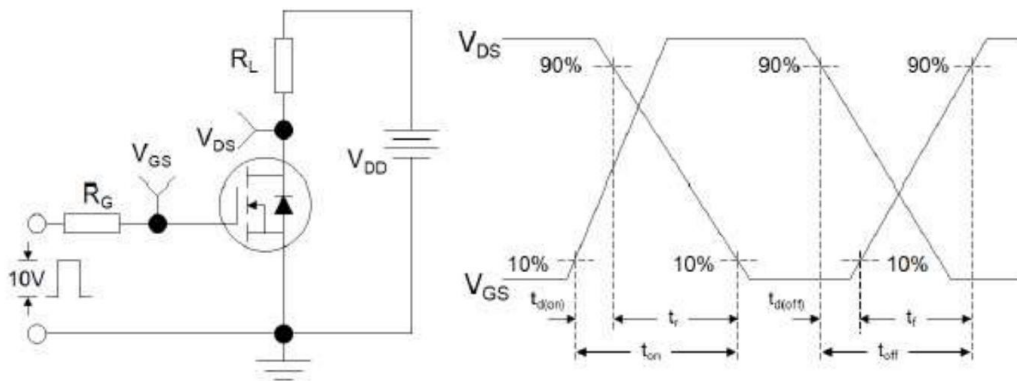

Figure 2: Resistive Switching Test Circuit & Waveforms

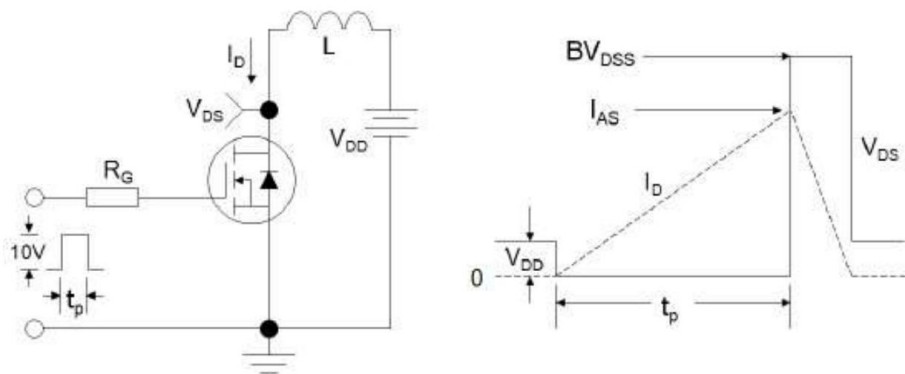
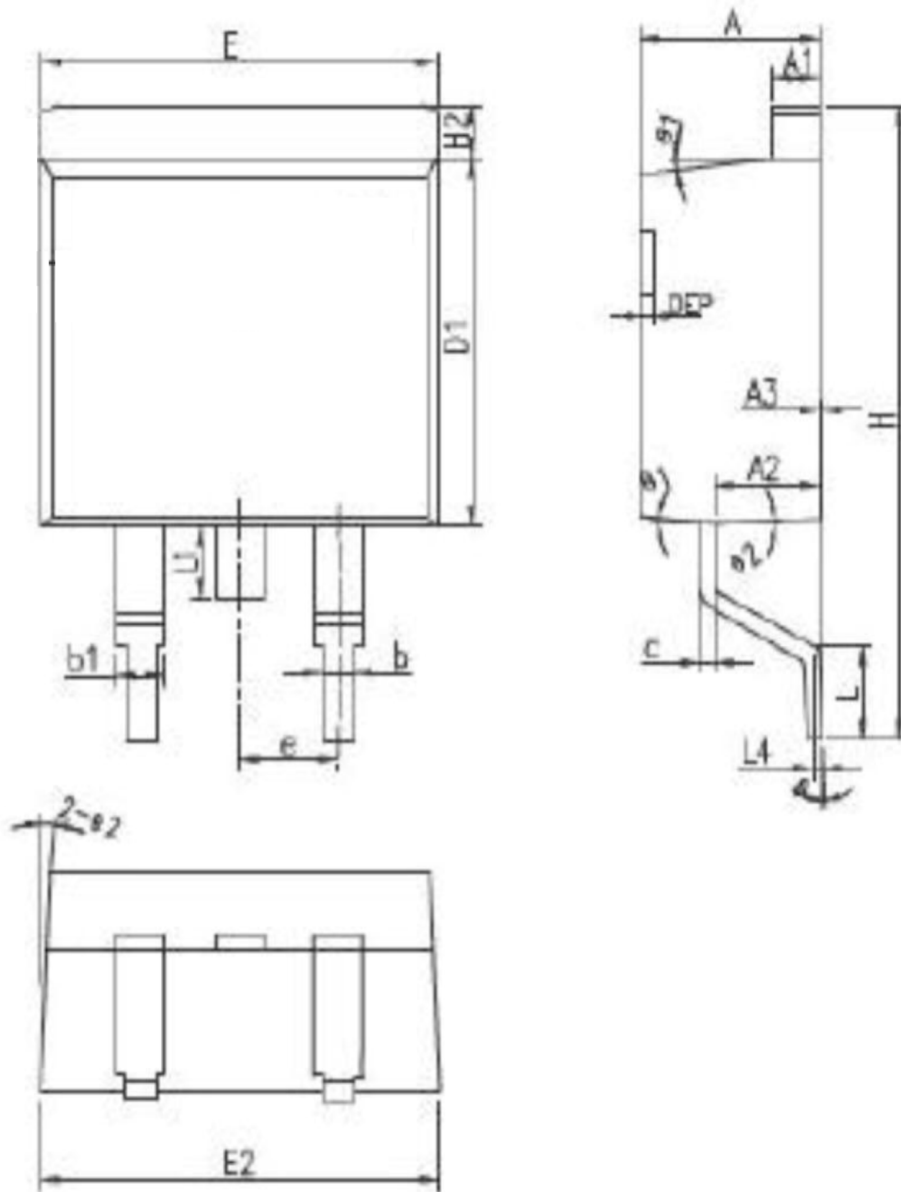

Figure 3: Unclamped Inductive Switching Test Circuit & Waveforms

PACKAGES DIMENSION : TO-263



Symbol	Inches			Millimeters		
	Min	Nom	Max	Min	Nom	Max
A	4.40	4.57	4.57	0.173	0.180	0.185
A1	1.22	1.27	1.27	0.048	0.050	0.052
A2	2.59	2.69	2.69	0.102	0.106	0.110
A3	0.00	0.10	0.10	0.000	0.004	0.008
b	0.77	0.813	0.813	0.030	0.032	0.035
b1	1.20	1.270	1.270	0.047	0.050	0.054
c	0.34	0.381	0.381	0.013	0.015	0.019
D1	8.60	8.70	8.99	0.339	0.343	0.354
E	10.00	10.16	10.16	0.394	0.400	0.404
E2	10.00	10.10	10.10	0.394	0.398	0.402
e	2.54BSC			0.100BSC		
H	14.70	15.10	15.50	0.579	0.594	0.610
H2	1.17	1.27	1.40	0.046	0.050	0.055
L	2.00	2.30	2.60	0.079	0.091	0.102
L1	1.45	1.55	1.70	0.057	0.061	0.067
L4	0.25BSC			0.010BSC		
θ	0°	5°	8°	0°	5°	8°
θ1	5°	7°	9°	5°	7°	9°
θ2	1°	3°	5°	1°	3°	5°
DEP	0.05	0.10	0.20	0.002	0.004	0.008

PACKAGES DIMENSION : TO-220

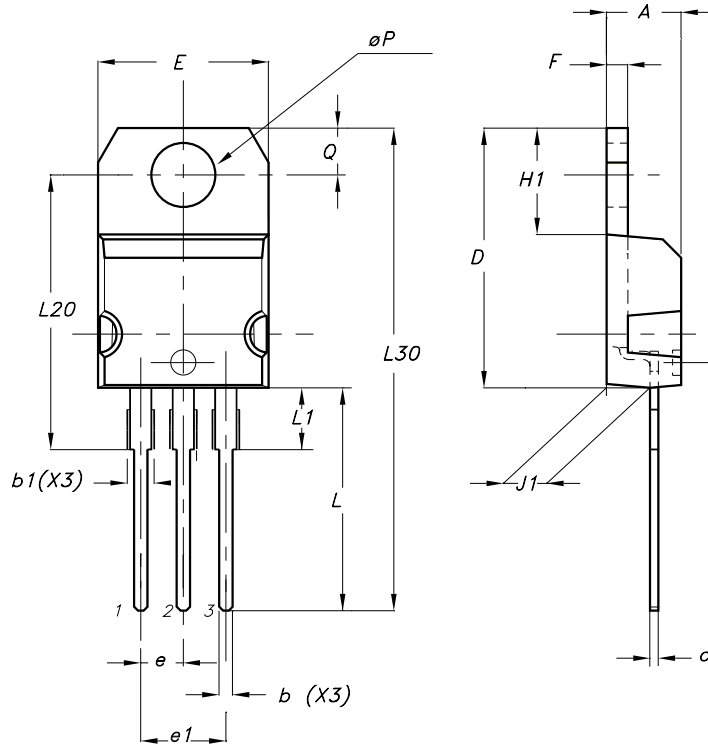

DIM.	mm.			inch		
	MIN.	TYP	MAX.	MIN.	TYP.	MAX.
A	4.40		4.60	0.173		0.181
b	0.61		0.88	0.024		0.034
b1	1.15		1.70	0.045		0.067
c	0.49		0.70	0.019		0.027
D	15.25		15.75	0.600		0.620
E	10.0		10.40	0.393		0.409
e	2.4		2.7	0.094		0.106
e1	4.95		5.15	0.194		0.203
F	1.23		1.32	0.048		0.051
H1	6.2		6.6	0.244		0.260
J1	2.40		2.72	0.094		0.107
L	13.0		14.0	0.511		0.551
L1	3.5		3.93	0.137		0.154
L20		16.4			0.645	
L30		28.9			1.138	
φP	3.75		3.85	0.147		0.151
Q	2.65		2.95	0.104		0.116

**Ordering information**

Order code	Package	Baseqty	Deliverymode	Marking
UMW IRFZ44NS	TO-263	800	Tape and reel	FZ44NS
UMW IRFZ44N	TO-220	1000	Tube and box	IRFZ44N